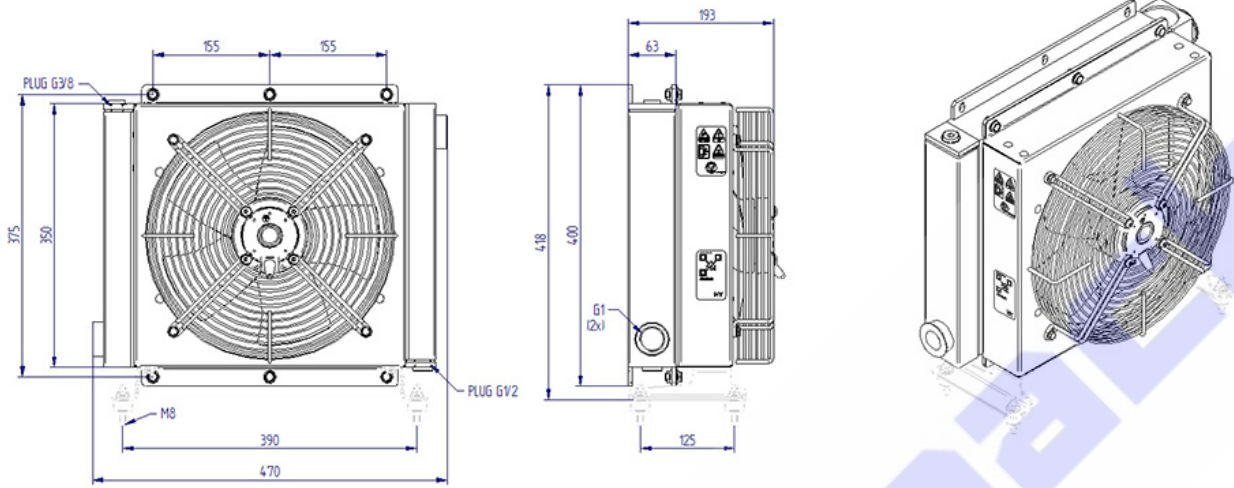
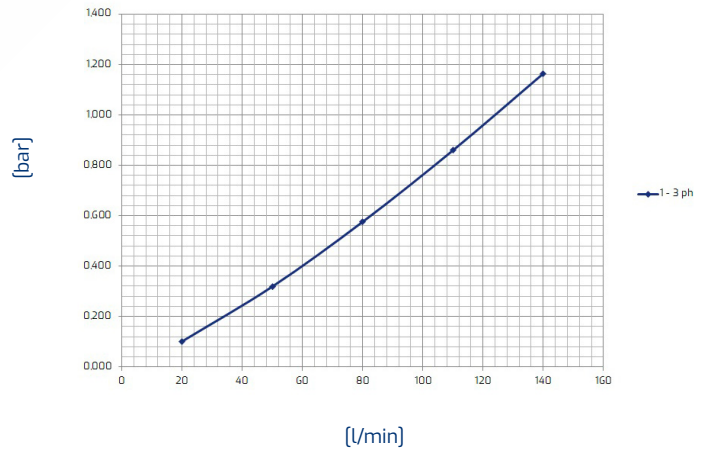
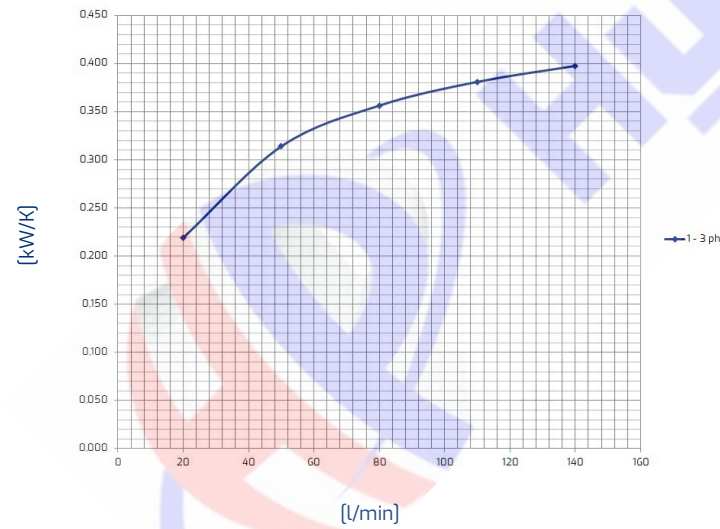

HY series
HY03801

Technical data

Item	Oil flow [l/min]	Capacity [l]	Weight [kg]	Rpm	Voltage [V]	Frequency [Hz]	Current absorption [A]	Power [W]	Ø Fan [mm]	Air flow [m³/h]	Noise level [db(A)]
HY03801	20-140	2,5	14,5		230	50/60	1,20	280	300	2160	73
HY03803	20-140	2,5	14,5		230/400	50/60	0,36	210	300	2150	72

Performance
Pressure drop

 Oil T 80°C
 T Amb. 40°C

Viscosity - ISO VG 32 Oil

Oil	22	32	46	68	150
Correction factor	0,8	1	1,2	1,6	3